 **KENWOOD**

**COMMUNICATIONS RECEIVER
NACHRICHTENEMPFÄNGER
RECEPTEUR DE COMMUNICATIONS
RECEPTOR DE COMUNICACIONES**

Model R-1000



**INSTRUCTION MANUAL
BEDIENUNGSANLEITUNG
MODE D'EMPLOI
MANUAL DE INSTRUCCIONES**

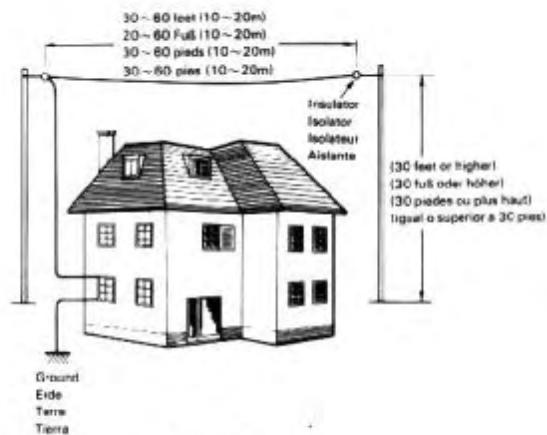

Fig. 1-1

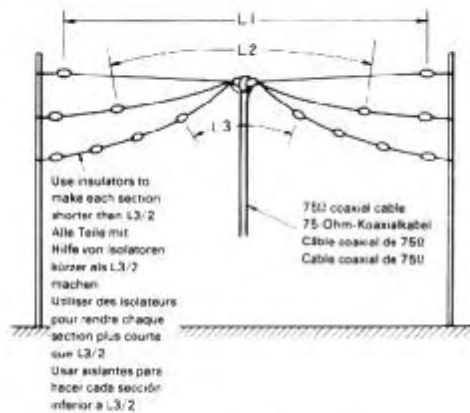

Fig. 1-4

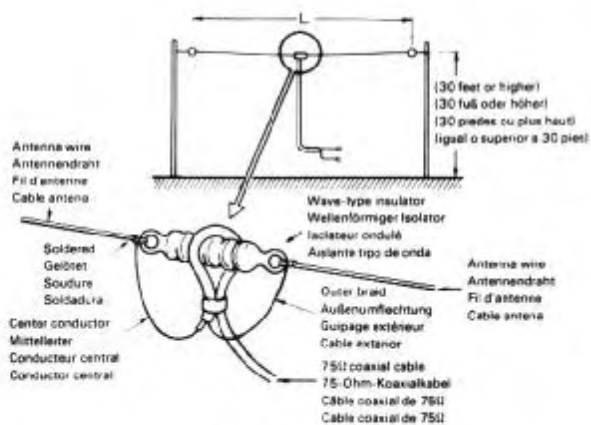

Fig. 1-2



Fig. 1-5

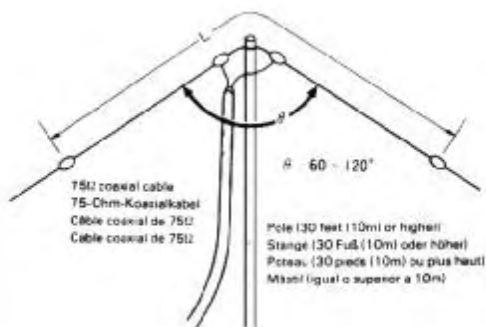

Fig. 1-3



Fig. 1-6

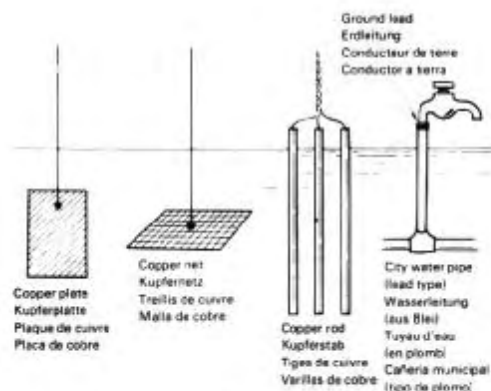

Fig. 1-7

You are now the owner of an exciting product, the R-1000 communications receiver. Please read this instruction manual carefully before placing your receiver in service. The unit has been carefully engineered and manufactured to rigid quality standards, and should give you satisfactory and dependable operation for many years.

AFTER UNPACKING

SHIPPING CONTAINER:

Save the boxes and packing in the event your unit needs to be transported for remote operation, maintenance or service.

CONTENTS

FEATURES	2
SPECIFICATIONS	3
SECTION 1. INSTALLATION	3
SECTION 2. CONTROLS	4
SECTION 3. OPERATING INSTRUCTIONS	5
SECTION 4. ENJOYING SW RECEPTION	10
SECTION 5. ADDITIONAL INFORMATION	13
OPTIONAL ACCESSORIES	54
BLOCK DIAGRAM	55
SCHEMATIC DIAGRAM	56

FEATURES

1. The Model R-1000 is a professional class general coverage receiver for broadcast and shortwave listening. It covers the 200 kHz through 30 MHz bands for reception of SSB, CW and AM.
2. The heart of the receiver includes a highly stabilized VFO and PLL synthesizer for trouble-free reception.
3. The circuits include band-pass filters interlocked with the band selector switch for ease of tuning.
4. The ceramic filter circuit is also interlocked with the mode switch. Selectivity matching each receive mode is obtained at all times.
SSB/CW → 2.7 kHz AM-NARROW → 6 kHz
AM-WIDE → 12 kHz
5. The built-in NB (noise blanker) circuit reduces pulsating, ignition type noises.
6. The RF attenuator provides three levels of 20 dB, 40 dB and 60 dB attenuation, making it possible to receive strong local signals without distortion.
7. The frequency display uses easy-to-read fluorescent tubes, which indicate true operating frequency accurate to the 1kHz order. The light intensity of the display, S meter and analog dial can be adjusted simultaneously by means of a dimmer switch.
8. The frequency display also functions as a quartz digital clock, permitting unattended tape recording or wake-up to the radio. Time is displayed in a 12-hour format with AM and PM signs illuminated.
9. The antenna terminals can be selected according to the signal frequency or the antenna system employed.

**INTERCONNECTION
ZWISCHENVERKABELUNG**

**INTERCONNEXION
INTERCONEXIONES**

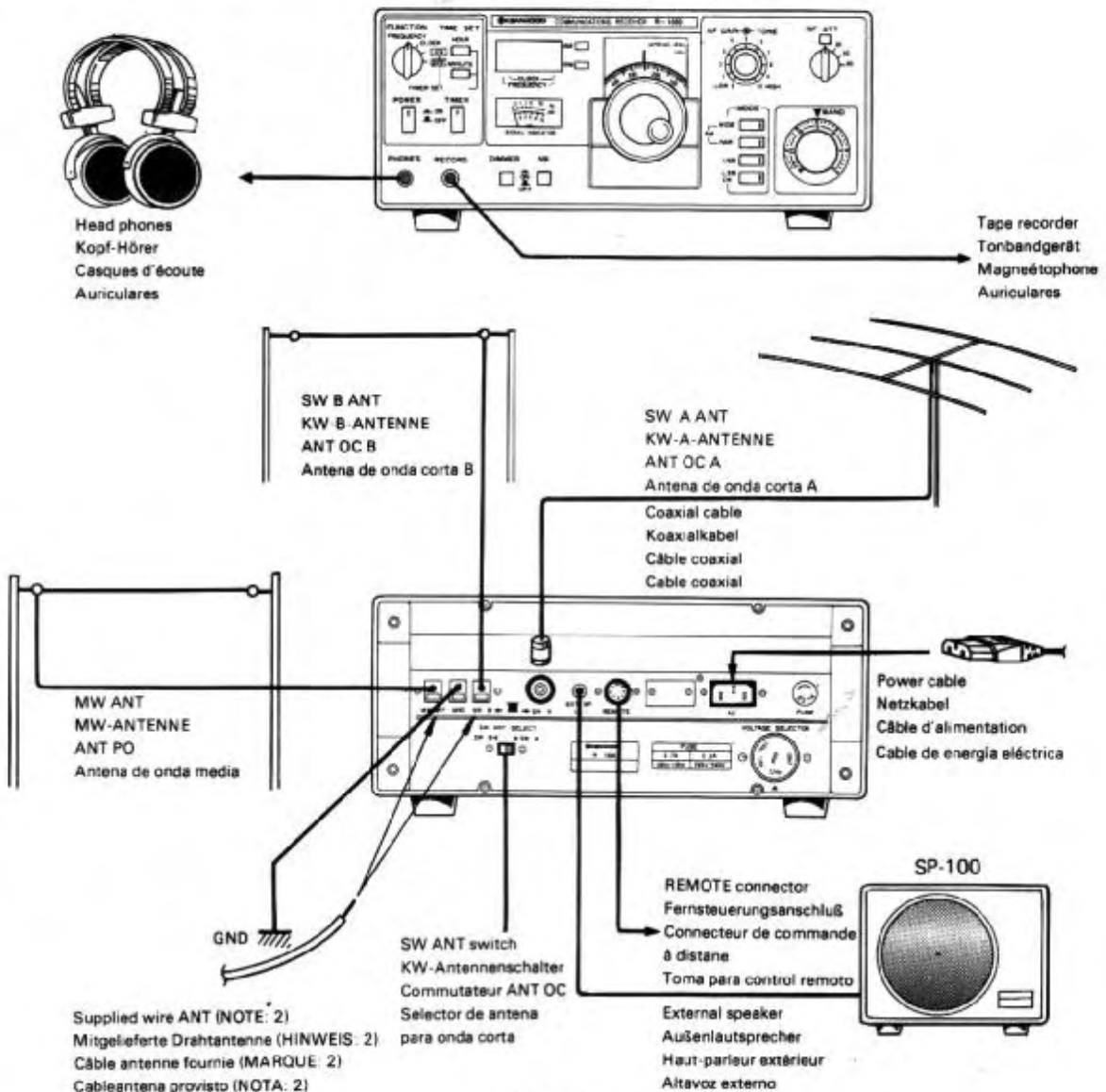

Fig. 1-8

NOTE:

1. Fig. 1-8 shows an example of R-1000 interconnection. A suitable antenna should be selected (see pages 1 and 3).
2. A simpler (but less effective) antenna system is achieved by connecting the supplied wire antenna to MW ANT (less than 2 MHz) or SW B (more than 2 MHz) of the antenna connector. When using SW B terminal, be sure that SW ANT SELECT switch is set to SW B position.
3. The SW A terminal should be used for a low impedance antenna (50Ω ~ 75Ω) fed with coaxial cable.

HINWEISE:

1. Abb. 1-8 zeigt ein Beispiel der Zwischenverkabelung am R-1000. Die für dieses System geeignete Antenne sollte unter Bezugnahme auf Seite 1, 3 gewählt werden.
2. Für einfaches Anschließen der mitgelieferten Drahtantenne mit dem Antennenanschluß MW ANT (weniger als 2 MHz) oder SW B (mehr als 2 MHz) verbinden. Bei Verwendung des Anschlusses SW B sicherstellen, daß sich der Kurzwellenantennen-Wahlschalter (SW ANT SELECT) auf SW B eingestellt ist.
3. An den Anschluß SW A sollte eine Antenne mit niedriger Impedanz (50 ~ 75Ω) mittels Koaxialkabel angeschlossen werden.

NOTA:

1. La Fig. 1-8 donne un exemple de l'interconnexion du R-1000. En ce qui concerne le système d'antenne, une antenne appropriée devrait être choisie en se référant aux pages 1, 3.
2. De manière simple, connecter le fil d'antenne fourni à MW ANT (moins de 2 MHz) ou SW B (plus de 2 MHz) du connecteur d'antenne. Quand le borne SW B est utilisée, s'assurer que le commutateur SW ANT SELECT est sur la position SW B.
3. La borne SW A devrait être utilisée pour une antenne à faible impédance (50Ω ~ 75Ω) avec le câble coaxial.

NOTA:

1. La Fig. 1-8 ilustra un ejemplo de las distintas conexiones del R-1000. La antena más apropiada debe seleccionarse de acuerdo con las páginas 1, 3.
2. El cableantena provisto con el aparato debe conectarse al terminal de onda media (MW ANT) (menos de 2 MHz) o al terminal de onda corta (SW B) (más de 2 MHz). Al utilizar el terminal SW B, asegúrese que el selector de antena para onda corta (SW ANT SELECT) se encuentre en la posición "SW B".
3. El terminal de onda corta SW A debe utilizarse para una antena de baja impedancia (50Ω ~ 75Ω) conectada a través de un cable coaxial.

SECTION 1. INSTALLATION

R-1000 SPECIFICATIONS

Frequency Range	200 kHz — 30.0 MHz
Mode	AM, SSB, CW
Sensitivity (10 dB or more S + N/N):	
200 kHz — 2 MHz (Antenna impedance: 1 k Ω)	
AM (NARROW, TONE:	
Center)	20 μ V
SSB	5 μ V
2 MHz — 30 MHz (Antenna impedance: 50 Ω)	
AM (NARROW, TONE:	
Center)	2 μ V
SSB	0.5 μ V
Image Ratio	More than 60 dB
IF Rejection	More than 70 dB
Selectivity:	
AM (WIDE)	12 kHz at — 6 dB, 25 kHz at — 50 dB
AM (NARROW)	6 kHz at — 6 dB, 18 kHz at — 50 dB
SSB/CW	2.7 kHz at — 6 dB, 5 kHz at — 60 dB
Frequency Stability	\pm 2 kHz max. from 1 to 60 minutes after power on \pm 300 Hz max. in every subsequent 30 minutes
Antenna Impedance	MW 200 kHz — 2 MHz, 1k Ω (unbalanced) SWA 2 MHz — 30 MHz, 50 Ω (Unbalanced) SWB 2 MHz — 30 MHz, 1k Ω (unbalanced)
Audio Output	1.5W min. (8 Ω load, 10% distortion)
Audio Load	
Impedance	4 — 16 Ω , external speaker or headphone
Power Consumption	20W
Power Requirements	100, 120, 220, 240V, AC, 50/60 Hz
Semiconductors	14 ICs, 11 FETs, 64 transistors, 72 diodes, 1 display tube
Dimensions	W 300 mm (12-3/4 inch) H 115 mm (4-1/2 inch) D 218 mm (8-9/16 inch)
Weight	5.5 kg (12.1 lbs)

CLOCK SECTION

Type	Quartz
Accuracy	\pm 15 seconds max./month

1.1 GENERAL

To obtain maximum performance from your R-1000 receiver, it is recommended you read Sections 2 and 3 in their entirety before attempting to operate the unit.

1.2 ACCESSORIES

The following accessory items are included:

1. Operating manual 1 copy
2. AC power cable 1 piece
3. Wire for antenna 5m
4. Miniature Speaker plug 1 piece
5. Fuse (0.7A) for 100/120V operation 2 pieces
or fuse (0.4A) for 220/240V operation 2 pieces
6. Remote connector (7P) 1 piece

1.3 OPERATING LOCATION

As with any solid state electronic equipment, the R-1000 should be kept from extremes of heat and humidity. Choose an operating location that is dry and cool, and avoid operating the receiver in direct sunlight.

1.4 ANTENNA

• Antenna and Grounding

Installation of antenna and grounding is important for optimum reception of short-wave, broadcast or amateur radio signals. A good outdoor antenna will provide the best results.

The following describes various antenna types and their installation.

NOTE:

A simple method is to install the supplied wire antenna as high as possible. It must be extended to its full length for good results.

• Long Wire Antenna

This is the simplest antenna, using about 30 ~ 1000 feet (10 ~ 30m) of wire installed between poles, trees or other convenient supports. The antenna wire should be heavy 8gauge vinyl insulated, stranded wire or 4-gauge copper wire or Copperweld. This type of antenna must be installed horizontally to a length of 60 feet (20m) or more, and be positioned as high as possible. Note that it should be as far away as possible from AC power lines, buildings, trees and other objects.

Fig. 1-1 shows an inverted L antenna. Other antenna types such as sloping, vertical, etc. are also possible.

A long-wire antenna, when installed in an open area, is suitable for all-band operation. (See Fig. 1-1)

• Doublet Antenna

This type of antenna is suitable for reception of a specific band.

The relation between the overall length "L" and the tuned frequency is:

$$L (m) = \frac{143}{\text{Freq (MHz)}} \quad K (\text{feet}) = \frac{468}{\text{freq (MHz)}}$$

This antenna is directional. Signal strength is maximum when the antenna is at a right-angle (broadside) to the desired signal and the frequency for which the antenna is cut. It must be used with a 75-ohm coaxial feeder. (See Fig. 1-2)

● Inverted V Antenna

This is a modified doublet antenna, designed to be installed on a single pole or support. The characteristics of this antenna are almost the same as those of a doublet. The overall length "L" is a little more than that of a doublet, and is computed thus:

$$L \text{ (m)} = \frac{148}{\text{Freq (MHz)}} \quad L \text{ (feet)} = \frac{486}{\text{Freq (MHz)}}$$

(See Fig. 1-3)

● Multiband Antenna

This antenna uses more than one doublet for multiband reception. The overall length "L" is the same as that of the doublet. If the lengths L1, L2 and L3 are cut for 7 MHz, 14 MHz and 28 MHz, then L1 is tuned to 21 MHz (3 x 7MHz), permitting reception on 4 amateur bands 7 ~ 28 MHz. When used only for reception, this antenna will cover the 6 ~ 30 MHz SW bands. (See Fig. 1-4)

● Trap Vertical Antenna

Antennas designed exclusively for BCL are available commercially, or may be built yourself. Antennas designed for HAM band (3.5 ~ 28 MHz or 7 ~ 14 MHz) operation will provide satisfactory broadcast reception for stations near the SW bands. Antennas of this type are most suitable for the listener who does not have enough space for installation of a doublet or long-wire antenna. (See Fig. 1-5)

● Yagi Antenna

The Yagi antenna is best suited for reception in a specific band. This antenna features excellent directivity; it provides high gain and minimizes interference when properly installed. Yagi antennas commercially available are designed only for HAM band reception. For SW reception, it will be necessary for you to construct such antennas yourself. (See Fig. 1-6)

● Grounding

Normally, the receiver will operate without being grounded. However, a good earth ground improves the efficiency of antennas such as a long-wire. It also eliminates inductive noise and protects the operator from electric shocks through the AC lines.

To ground the receiver, use a copper or brass plate (or net or rod) connected to a copper wire, and bury it in the ground about 1 ~ 7 feet (0.3 ~ 2.0m) deep. A copper water pipe (not plastic) may also be used. Never use a gas pipe for grounding.

If the receiver cannot be grounded well, the counterpoise (antenna radial) would be acceptable.

1.5 SPEAKER

Audio output from the R-1000 is 1.5 watts into 8 ohms. The R-1000 has a built-in speaker. However, if an external speaker is desired (such as the KENWOOD SP-100), simply connect it to the SPEAKER jack of the rear panel. The speaker may be any good 8 ohm permanent magnet type, 4 inches or larger.

The internal speaker is disconnected when an external speaker is used.

1.6 HEAD PHONES

Any low-Z (4 ~ 16 ohm) headphones may be used with the R-1000. Connect the headphones to the front-panel phone jack.

If a speaker is connected to the receiver, it will automatically be disconnected when the headphones are plugged into the jack.

1.7 POWER REQUIREMENTS

The R-1000 operates from 100/120/220/240 VAC, 50 ~ 60 Hz. Stability is not affected within 10% of line voltage variation, due to the built-in regulated power supply.

To change the voltage selector position, refer to Section 4.9.

CAUTION:

Operation of this receiver with a wrong power source may result in serious damage, and is not covered by the manufacturer's warranty.

1.8 CONNECTION

MW ANT Terminal

Connect a high impedance antenna such as a long wire antenna for reception of LW or MW signals of less than 2 MHz.

SW B Terminal

Connect a high impedance antenna such as a long wire antenna for reception of signals above 2 MHz. The SW ANT switch should be set to the SW B position.

SW A Terminal

Used for receiving signals above 2 MHz. The antenna feeder should be a coaxial cable equipped with a UHF connector.

GND Terminal

It is recommended that a short, heavy ground lead be connected to the GND terminal (rear panel) to prevent the possibility of electric shock.

Headphones

Use headphones of 4 to 16 ohm impedance. The optional HS-4 or HS-5 headphones are best suited for use with the R-1000. Stereo type headphones can also be used.

External Speaker

Besides the built-in speaker, an external speaker can also be used (such as the optional SP-100). Connect to the rear panel EXT SP jack using the supplied plug.

OUTSIDE VIEWS
AUSSENSEITE

LA VUE L'EXTERIEUR
VISTA EXTERIOR

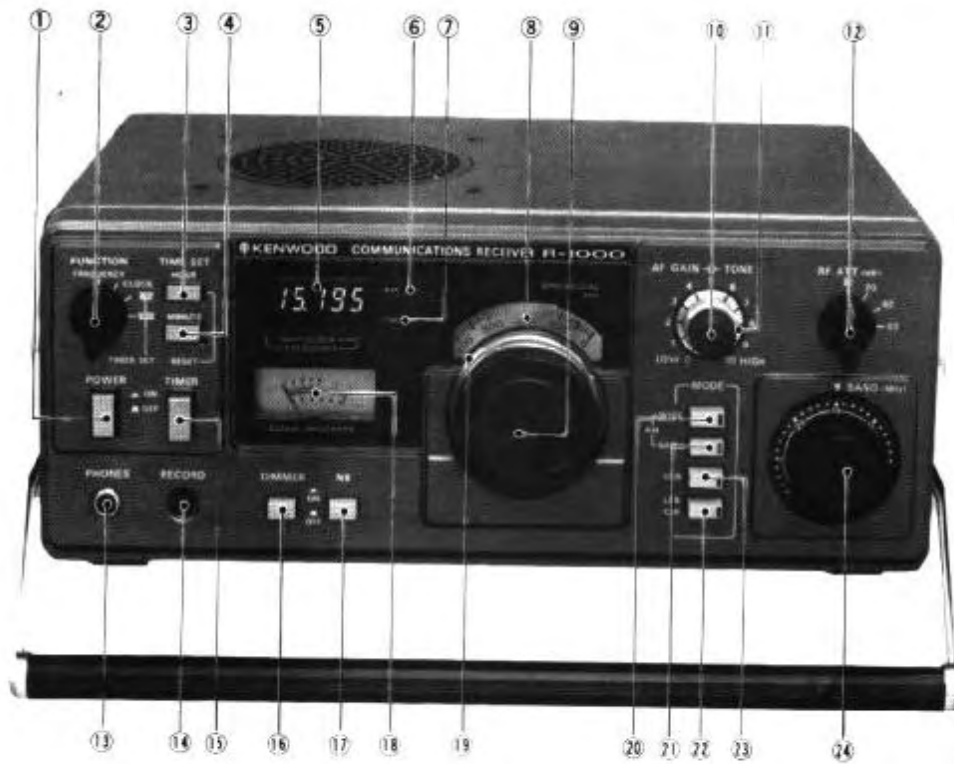

Fig. 2-1

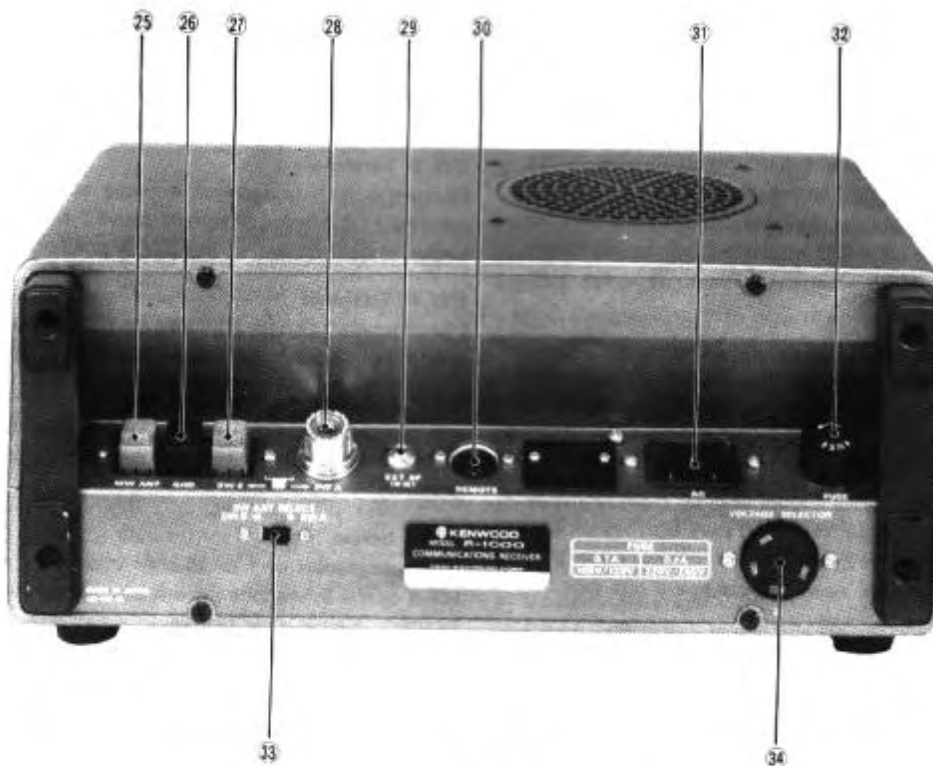

Fig. 2-2

SECTION 2. CONTROLS

[FRONT PANEL] (See Fig. 2-1)

1. POWER Switch

This switch controls power to the R-1000.

NOTE:

The digital clock operates continuously (even when the power switch is OFF).

2. FUNCTION Switch

This switch selects the digital display functions.

FREQUENCY	Frequency is displayed accurate to the 1 kHz order.
CLOCK	Time is displayed in 12-hour format.
TIMER SET "ON"	The timer operates to indicate turn-on time.
TIMER SET "OFF"	The timer operates to indicate turn-off time.

3. HOUR Switch

This is used for setting time (in hours) for both the clock and the timer. The time will advance by 1 hour at each press of the switch depressed for more than 2 seconds.

4. MINUTE Switch

This is used for setting time (in minutes) for both the clock and the timer. The time advances by 1 minute at each press of the switch. To advance the time continuously, keep the switch depressed for more than 2 seconds.

NOTE:

When the HOUR and MINUTE switches are pressed at the same time, the clock indicates 1:00 AM and the timer indicates 0:00 AM. When these switches are released, the clock time is indicated.

5. Digital Display

The digital display unit indicates operating frequency and time. Frequency or time selection is accomplished by the FUNCTION switch.

6. AM Indicator

This lights to indicate the time being set is AM (before noon).

7. PM Indicator

This lights to indicate the time being set is PM (afternoon).

8. Main Dial

This analog dial is calibrated at 10 kHz intervals from 0 to 1,000 kHz.

9. Main Tuning Knob

This selects the receiver's operating frequency. First select the frequency in MHz by the BAND switch (24), then the frequency in kHz by the main tuning.

10. AF GAIN Control

This varies the audio output. Turning clockwise will increase the volume.

11. TONE Control

This adjusts audio tone quality. Normally set at the center position.

12. RF ATT (Attenuator) Switch

This switch allows precise input signal attenuation in four steps: 0 dB, 20 dB, 40 dB and 60 dB.

13. PHONES Jack

This jack accepts 4 to 16 ohm impedance headphones. Stereo headphones may be used. The optional HS-5 headphone is best suited.

14. RECORD Jack

This terminal is used for recording broadcasts on tape. Connect it to the LINE IN on your tape recorder. The output level at this terminal is constant, regardless of the R-1000 AF GAIN control position.
(Output level: 30 mV, Impedance: 100 k Ω)

15. TIMER Switch

This switch turns the timer ON.

16. DIMMER Switch

This reduces the light intensity of the digital display, meter and dial when the receiver is operated in the dark.

17. NB (Noise Blanker) Switch

Turn ON to reduce pulsating, ignition-type noises.

18. Meter

Indicates received signal strength.

19. Dial Calibrate Knob

Use this to calibrate the main dial. Turning the main dial will also rotate the dial calibrate knob. Do not use this knob for tuning.

MODE Switch Group

20. AM-WIDE Switch (See page 13 on changing the bandwidth.)

With the MODE switch in this position, bandwidth is broad, improving the tone quality of AM reception.

21. AM-NARROW Switch (See page 13 on changing the bandwidth.)

Use this position when interference is present at the AM-WIDE setting. Bandwidth is narrow, reducing interference for easier AM reception.

22. LSB/CW (Lower Side Band/Continuous Wave) Switch

This switch is used to receive SSB (LSB) or CW signals.

23. USB (Upper Side Band) Switch

This switch is used to receive SSB (USB) signals.

24. BAND Switch

Use this switch to select the frequency band in MHz. Calibration is from 0 to 29 at 1 MHz intervals.

[REAR PANEL] (See Fig. 2-2)

25. MW ANT Connector

Connect a high impedance long-wire antenna when the received frequency is lower than 2 MHz.

SECTION 3. OPERATING INSTRUCTIONS

26. GND Terminal

Ground terminal. The ground cable should be as short as possible. Select a good ground point.

27. Antenna Connector (SW B)

For connection of a high impedance long wire antenna when the received frequency is higher than 2 MHz. The SW ANT SELECT switch (33) should be set to SW B.

28. Antenna Connector (SW A)

For connection of a 50 ~ 75 ohm coaxial cable with UHF connector for signals above 2 MHz. The SW ANT SELECT switch (33) should be set to SW A.

With an antenna connected to the SW A or SW B terminal, MW broadcast can also be received without connecting an antenna to the MW ANT terminal. However, if you wish to receive weak signals, an appropriate antenna should be connected to the MW ANT terminal.

29. EXT SP Jack

For connection of an external speaker of 4 ~ 16 ohm impedance. The optional speaker SP-100 is best suited.

30. REMOTE Connector

The REMOTE connector provides various functions by using the relay circuit (interlocked with the timer), or the muting circuit. Typical application of this connector would be making unattended tape recordings, or using the R-1000 in combination with a transmitter. The R-1000 automatically mutes by this circuit when the transmitter is in operation.

31. AC Connector

Connect the supplied AC power cable.

32. FUSE

AC power fuse. Use a 0.7A fuse for 100/120V operation, and a 0.4A fuse for 220/240V operation.

33. SW ANT SELECT Switch

This switch is used to select the antenna terminal when the receiver frequency is higher than 2 MHz. For coaxial cable (50 ~ 75 ohms), set it to SW A position. For a high impedance antenna (long wire, etc.), set it to SW B position.

34. VOLTAGE SELECTOR

AC voltage selector switch. BEFORE operating, set this switch to your local line voltage. Consult the power company if in doubt.

3.1 RECEPTION

Connect the unit by referring to Fig. 1-B in Section 1. For best results, it is important to select an antenna that matches the received frequency. For reception of MW (medium wave) broadcast, connect a long-wire antenna to the MW ANT terminal. For good reception of SW (short wave) broadcast, connect the antenna through a coaxial cable to the SW A terminal. When using a long-wire antenna, connect it to the SW B terminal. Be sure to set the SW ANT SELECT switch to SW A or SW B according to the antenna terminal used.

1. Initial Control Settings

Before operating the unit, set the switches and controls per Fig. 3-1.

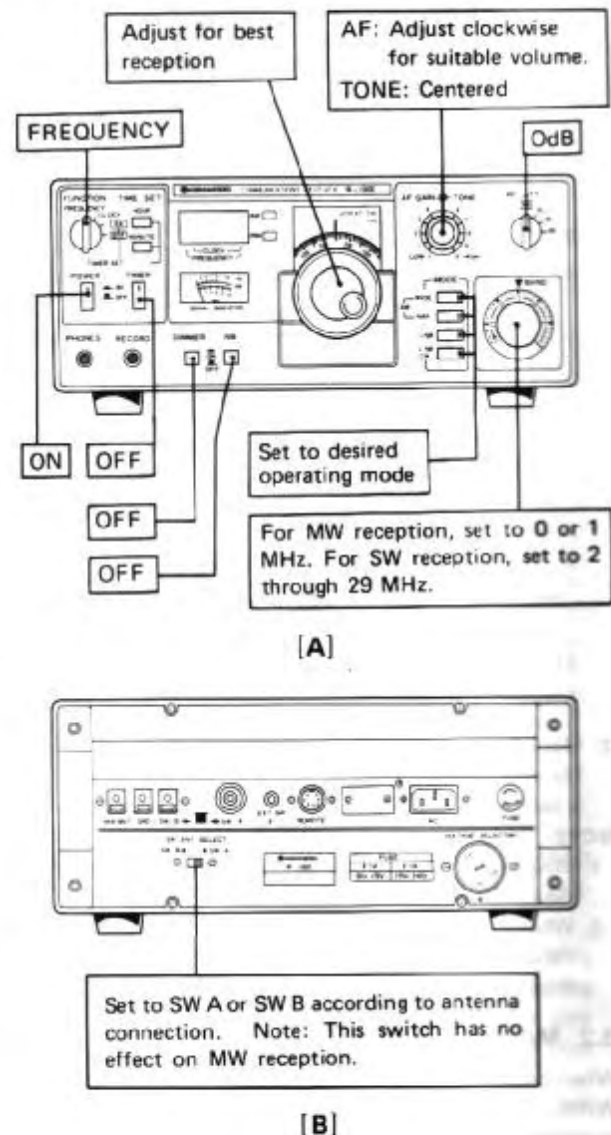

Fig. 3-1 Initial Settings

- 1) Reading the Operating Frequency
The R-1000 Digital Display accurately indicates frequency.
Refer to Fig. 3-2.

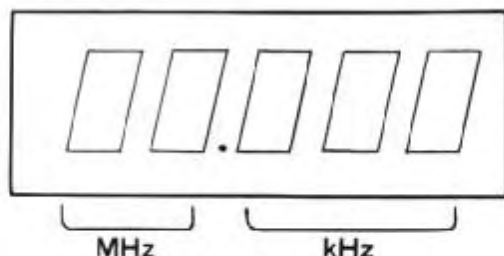

Fig. 3-2 Digital Display

- 2) Setting the Frequency
The BAND switch dial is calibrated at 1 MHz intervals from 0 to 29. Fig. 3-3 shows the dial set to 9 MHz.

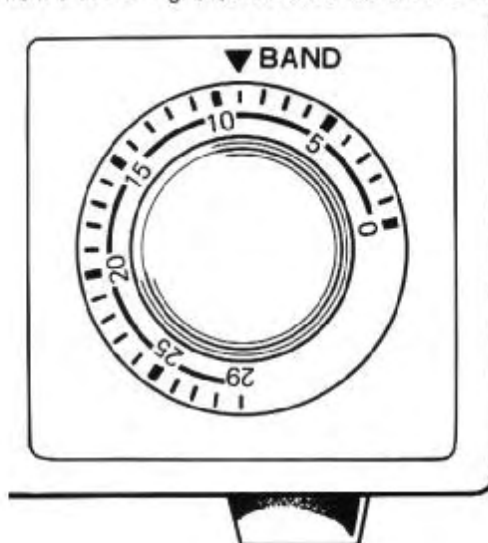

Fig. 3-3 BAND Setting 9 MHz

2. Main Dial

The main dial is interlocked with the main tuning knob. It is calibrated at 10 kHz intervals from 0 to 1,000 kHz.

NOTE:

1. When receiving a signal below 200 kHz, the receiver performance might be deteriorated.
2. When the receiver frequency is set to 0 mMHz 000kHz, the S-meter will deflect to the end. (This does not indicate a trouble.)

3.2 MODE SWITCH

When receiving strong local signals, set this switch to AM WIDE. This enhances reception with little interference, providing excellent tone quality.

When unwanted signals are present near the received frequency, set the switch to AM NARROW. This narrows the bandwidth, reducing radio interference.

For reception of SSB, press the USB or LSB/CW button according to international practice.

For reception of CW signals, press the LSB/CW button.

3.3 RF ATT SWITCH

If excessively strong nearby stations or high-power night broadcasts are present within the band being received, a desired signal may be blocked by receiver desensitization. Also, if a signal is very strong, the meter may deflect off-scale. Set the RF ATT switch to an appropriate position, 20 dB (1/10), 40 dB (1/100) or 60 dB (1/1000). At the 0 dB (1/1) position, the signal is not affected.

3.4 NB SWITCH

For pulse type noise, such as generated by automobile ignition systems, turn the NB switch ON. The noise will be reduced or eliminated.

3.5 DIMMER SWITCH

By pressing this switch, the light intensity of the digital display, meter and the main dial will be reduced.

Use this feature when the receiver is operated in the dark, as it reduces eye-strain.

Practical Operating Procedure

Radio stations throughout the world are listed in the **WORLD RADIO TV HANDBOOK** or similar publication. Radios frequency allocations are listed on page 12 of this manual.

Example I. Reception of MW (Medium Wave) stations.

- Connect the supplied wire antenna or a long wire antenna to the MW ANT terminal (25).
- Strong signals can be received clearly without being grounded. However, a good earth ground is recommended for weak signals.
If an earth ground is not available, a counterpoise (antenna radial) would be acceptable.
- Set the MODE switch to AM WIDE.
- Set the BAND switch (24) to 0 or 1 and tune in the desired station.
- If necessary, use the RF ATT switch (12), the NB switch (17), and the TONE control (11).
- If the audio output is not clear because of interference, set the MODE switch to AM NARROW (21).

Example II. Reception of SW (Short Wave) and LW (Long Wave) stations.

The SW and LW allocations vary throughout the world. (See page 12)

- For LW Reception.
Follow the procedures of Example I.
- For SW Reception
 - If the supplied wire antenna or a long wire antenna is used, connect it to the SW B terminal (27) and set the SW ANT SELECT switch (33) to the SW B position.

- b. For installation of a doublet antenna, vertical antenna, Yagi antenna or the like, a coaxial cable should be used. Connect it to the SW A terminal (28) and set the SW ANT SELECT switch (33) to the SW A position.
- c. The other operating procedures are the same as example I.

Example III. Reception of SSB (Single Sideband) or CW (Morse signal).

In commercial and Amateur radio, SSB and CW signals are used very often.

- a. In reception of amateur radio SSB signals, press the USB button when the frequency is higher than 10 MHz and press the LSB/CW button when it is lower than 10 MHz
In reception of commercial SSB signals, press an appropriate MODE button according to international practice.
- b. In CW reception, press the LSB/CW button.

3.6 DIGITAL CLOCK

To operate the digital clock, proceed: (See Fig. 3-4)

Set the FUNCTION switch to CLOCK.

Set the TIMER switch to OFF.

Press the HOUR switch to set time (hour).

Press the MINUTE switch to set time (minute).

When the HOUR and MINUTE switches are pressed simultaneously, the digital clock indicates "1:00" with the AM indicator lighted.

Release the HOUR and MINUTE switches. The digital clock will start operating, counting seconds from 00 (seconds not indicated on the display).

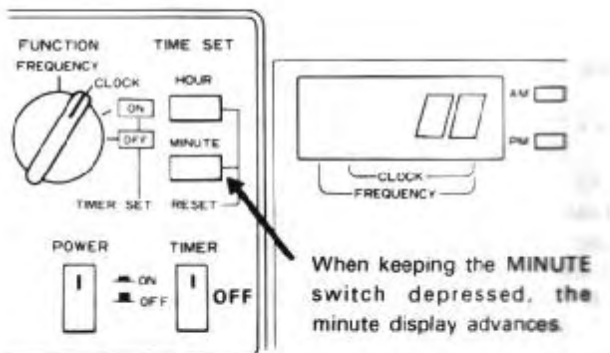
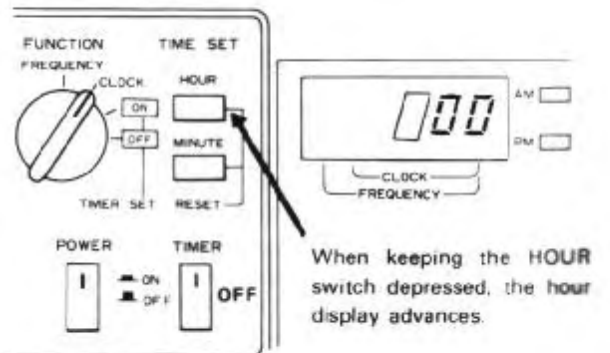
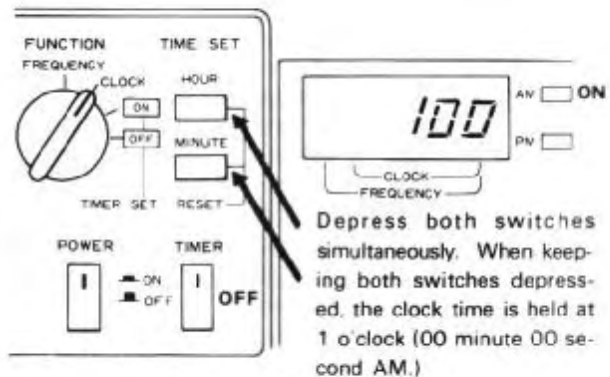

Fig. 3-4 Setting the Time

NOTE:

The digital clock keeps operating even when the POWER switch is OFF, as long as the power cable remains connected to the AC outlet.

HOUR switch Press this switch once and the time will advance by 1 hour. When the switch is kept depressed, the time will advance continuously at 1 hour intervals.

MINUTE switch Press this switch once and the time will advance by 1 minute. When the switch is kept depressed, the time will advance continuously at 1 minute intervals.

Example 1: Setting at 9:00 AM

Using a time signal from a radio station, zero the clock (second digits are not displayed).

- First depress and hold the HOUR and MINUTE switches simultaneously before the time signal is received. The clock is now set to 00 minute and 00 second, indicating 1:00.
- Release both the HOUR and MINUTE switches at the time signal. The clock will count seconds.
- Next, press the HOUR switch 8 times. As an alternative, keep the switch depressed, and release when the clock indicates 8:00. Then press the switch once again and the clock will indicate 9:00.

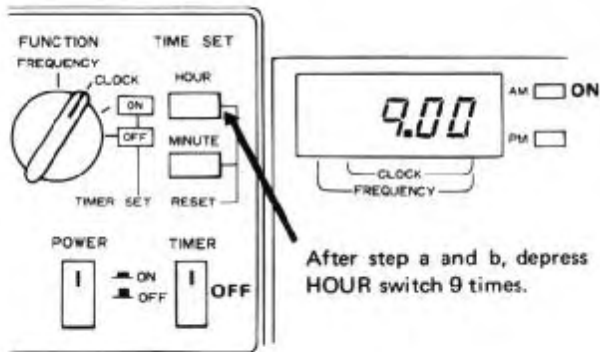

Fig. 3-5 Setting at 9:00 AM

NOTE:

When either switch has been pressed past the desired time, advance the clock until it returns to the desired time.

When pressing the HOUR switch, observe the AM or PM indicators.

Example 2: Setting at 2:15 PM

- First set the clock to 00 second using a time signal, as in Example 1.
- Next, keep the HOUR switch depressed. When the clock advances past 12:00 AM, the PM indicator will light. Release the HOUR switch at 2:00 PM.
- Press the MINUTE switch to set the minute digits to 15.

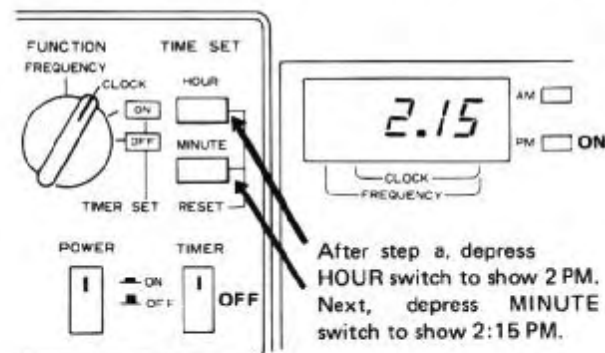

Fig. 3-6 Setting at 2:15 PM

3.7 TIMER

The timer turns ON and OFF at any designated time.

Example: To turn ON at 11:15 AM and OFF at 1:30 PM, proceed:

1. Setting the ON time (11:15 AM)

Turn the TIMER switch OFF.

Turn the FUNCTION switch ON.

- Depress the HOUR and MINUTE switches simultaneously. The clock indicates 0:00.
- Set the hour digits to "11" by pressing the HOUR switch.
- Next, set the minute digits to "15" by pressing the MINUTE switch.

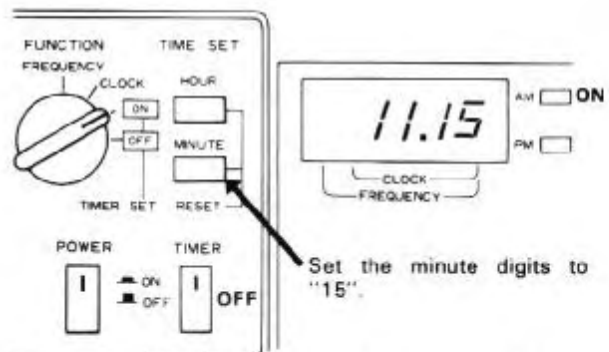
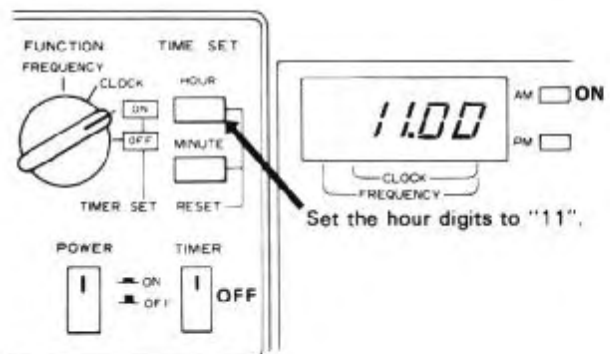
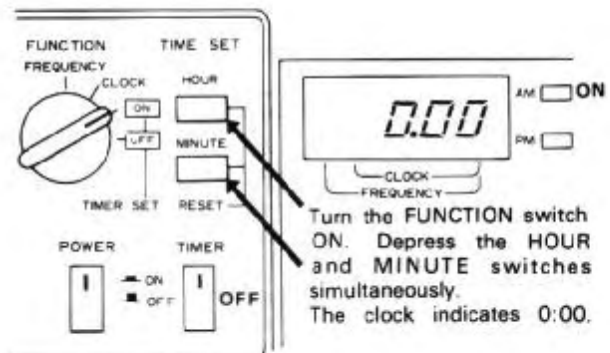

Fig. 3-7 Setting the ON Time (11:15 AM)

2. Setting the OFF time (1:30 PM)

Turn the TIMER switch OFF.

Turn the FUNCTION switch OFF.

- Set the clock to 0:00 by pressing the HOUR and MINUTE switches simultaneously.
- Set the hour digits to "1:00 PM" by the HOUR switch.
- Set the minute digits to "30" by the MINUTE switch.

The timer is now ready to turn ON and OFF automatically. Turn the TIMER switch ON and the R-1000 will turn ON at 11:15 AM and turn OFF at 1:30 PM every day.

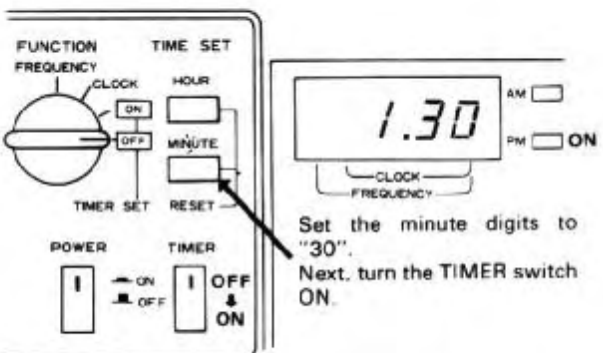
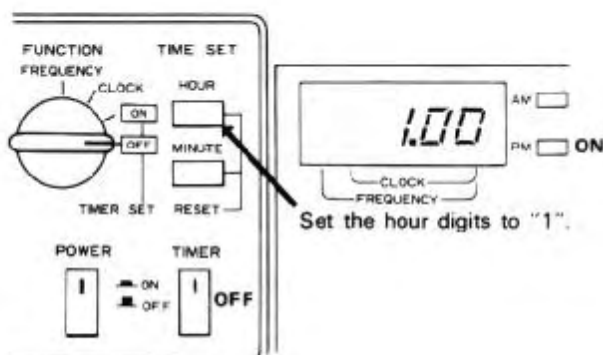
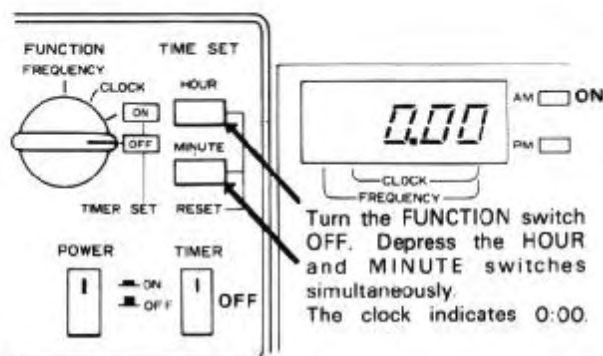

Fig. 3-8 Setting the OFF Time (1:30 PM)

NOTES:

- When the ON time is set behind the actual time (for example, 11:30 AM), the R-1000 will not turn on until 11:15 AM the following day.
- The timer will not turn off automatically unless ON-time is set. To use it as a sleep timer, set ON-time so that the R-1000 is operated after 1 minute or so, then set OFF-time.
- Once the TIMER switch is set to ON, the timer turns ON and OFF every day at the designated time. (The TIMER switch can not be effective if the FUNCTION switch is set to FREQUENCY position.)
- With the TIMER switch in the ON position, the timer keeps operating regardless of the position of the POWER switch.
- When setting the ON and OFF time be sure to change the position of the FUNCTION switch.

3.8 UNATTENDED RECORDING ON TAPE

The timer function feature also allows you to record a desired broadcast on tape even when you are away from home. The tape recorder to be used should be provided with the following functions:

- Recording terminal to accept external line input signals.
- Automatic start/stop circuit which controls tape record operation by external input signal.
- The tape recorder control terminals should be turned on and off by an external signal (starts at ON and stops at OFF).

Connections and Settings (See page 2 Fig. 1-8)

- Tune the R-1000 to the desired receive frequency, any operating mode.
- Connect the R-1000 RECORD jack to the LINE IN of your tape recorder (cable user supplied).
- Set the R-1000 timer to your desired ON and OFF time. Next, turn the TIMER switch ON.
- Connect the external control terminal of the tape recorder to the R-1000 REMOTE connector, pin 1 and pin 4.
- Set the tape recorder in record mode.

The tape recorder is now ready for unattended tape recording. When the timer reaches the ON-time, the R-1000 turns on and the built-in relay is activated to operate the tape recorder through the REMOTE connector (pins 1 and 4 are shorted). (See Fig. 3-9)

Mute Circuit

The R-1000 has a mute circuit for use in combination with a transceiver or transmitter.

The R-1000 RF stage will mute by grounding Pin 7 on the remote terminal. (See Fig. 3-9)

SECTION 4. ENJOYING SW RECEPTION

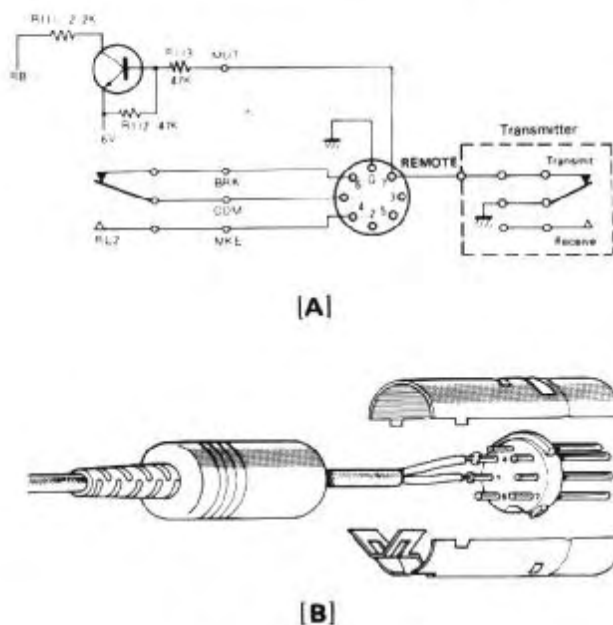

Fig. 3-9 Remote Terminal

NOTE:

The relay contact capacity for the REMOTE connector is less than 1A (resistive load) at 24 VDC. Voltage at the REMOTE connector should not exceed the AC power supply voltage.

3.9 AC VOLTAGE SELECTION

The R-1000 will operate on 100, 120, 220 or 240 VAC 50 or 60 Hz. For proper operation, select the power setting closest to your local line voltage.

If you are not sure of the local line voltage, contact the utility company. To reset the voltage selector, **FIRST DISCONNECT THE POWER CABLE.** Align the selector with the desired voltage using coin or screwdriver.

NOTE:

For DC operation, contact an authorized KENWOOD dealer.

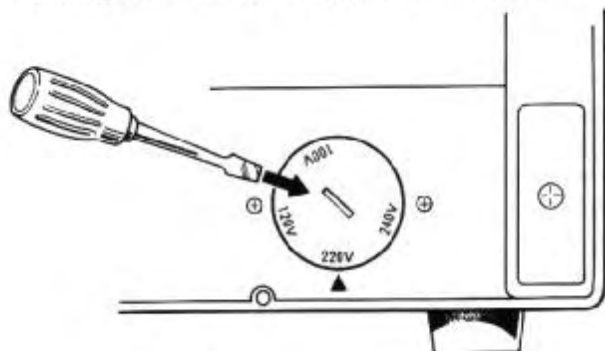

Fig. 3-10 AC Voltage Selection

ENJOYING SW RECEPTION

Every country in the world has broadcast stations, and most countries have Amateur radio stations. The earth is virtually surrounded by innumerable radio waves, providing us with information and news. Your R-1000 intercepts many of these transmissions.

Radio waves cover a wide range of frequencies including long-wave (LF), medium-wave (MF), and short-wave (SW) or high frequency (HF). Since short-wave signals travel around the earth, it is fun receiving exciting news and exotic music from overseas broadcast stations or transmissions from Amateur radio stations and various industrial, marine, government, and military. It is also interesting to collect reception or verification (QSL) cards. To ensure maximum enjoyment of short-wave reception, it is important to know the features of short-wave signals — how the signals travel around the earth, the method of receiving signals most effectively, the method of identifying the country broadcasting programs, etc.

Propagation of Radio Waves By the Ionosphere (See page 11 Fig. 4-1)

The earth is surrounded by the atmosphere. The atmospheric molecules existing between 50 km and 500 km above the earth collide with ultraviolet rays and electrons emitted from the sun, and a layer of electrons and ions is formed. This layer is called the ionosphere and it has a characteristic of refracting radio waves. Radio waves emitted from the antenna of a transmitter can be classified as surface waves and ionospheric waves. Surface waves travel along the earth directly, and are used mainly for medium frequency AM broadcast and TV and FM broadcast. Ionospheric (sky) waves travel a long distance because they are refracted repeatedly between the ionized layer and the earth. As short-wave broadcasts propagate by ionospheric waves, their signals often reach around the earth. The surface wave tends to weaken at HF and short-wave frequencies and therefore travel only a short distance, while ionospheric waves persist as the frequency increases (up to a certain point, determined by ionization intensity) and travel long distance with little path loss. Ultra high frequencies pass through the ionized layer, and thus the service area is limited to a short distance from the antenna. The ionosphere is divided into three layers, D, E and F, as shown in Fig. 4-1. The electron density in the layer is increased in steps according to the distance from the sun. High frequency waves are refracted by the F layer and travel a long distance.

	Frequency Band	Type of Radio Wave Propagation	
		Short-distance	Long-distance
VLF	Very Low Frequency (under 30 kHz)	Surface wave	Ionospheric wave
LF	Low Frequency (30 ~ 300 kHz)	Surface wave	Ionospheric wave
MF	Medium Frequency (300 ~ 3,000 kHz)	Surface wave	Ionospheric wave
HF	High Frequency (3 ~ 30 MHz)	Ionospheric wave	Ionospheric wave

Table 1.

The state of the ionized layer is closely associated with the relative positions of the sun and the earth and also with the activity of the sun. The D and E layers almost disappear at night, while the F layer changes in height and density depending on daytime or night time, and changes the upper frequency limit to be reflected. Occasionally, "clouds" of ions will drift through the E layer, causing strong signal propagation (called "sporadic E propagation") over several hundred miles, usually between 15 MHz and 30 MHz, and sometimes higher in frequency.

Such a phenomenon also occurs with changes in seasons or rotation cycle of the sun as well as unusual activities of the sun (change in the sunspot cycle every 11 years, unexpected explosion on the sun, etc.). To cope with this, international short-wave broadcast stations change their frequencies according to seasons or directions of radio waves, or use different frequencies at the same time for broadcasting the same program.

Frequency Distribution in the Broadcast and Amateur Bands.

The R-1000 receiver covers a wide frequency range extending from 200 kHz to 30 MHz, to receive the internationally determined frequencies assigned to many broadcast and communications services.

As shown in the Frequency Allocation Chart, Fig. 4-2, broadcast and Amateur radio station frequencies are allocated in specific bands expressed in megahertz (MHz) or wavelength in meters (m). Also in Fig. 4-2, the frequencies of "other stations" are assigned for fixed station business use, marine mobile, aviation mobile, land mobile, radio beacon stations, etc. The following relationship exists between frequency and wave length:

$$\begin{aligned} \text{Wave-length (m)} &= \frac{300}{\text{Frequency (MHz)}} \\ &= \frac{300,000}{\text{Frequency (kHz)}} \\ \text{Frequency (MHz)} &= \frac{300}{\text{Wave length (m)}} \end{aligned}$$

As will be seen from this relationship, the 31m band and 9 MHz band, for example, are the same shortwave broadcast band, covering the range of 9.500 kHz to 9.775 kHz.

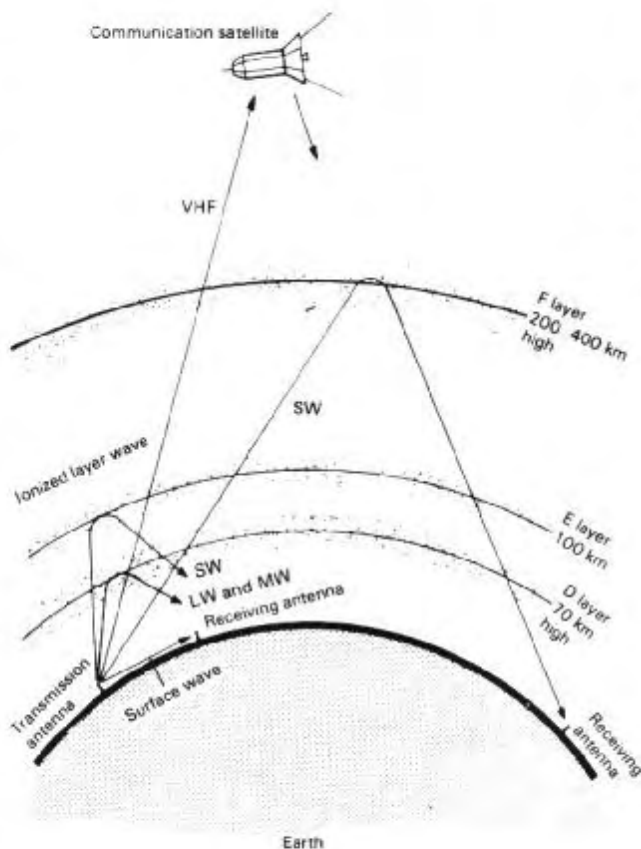

Fig. 4-1

RADIO FREQUENCY ALLOCATION

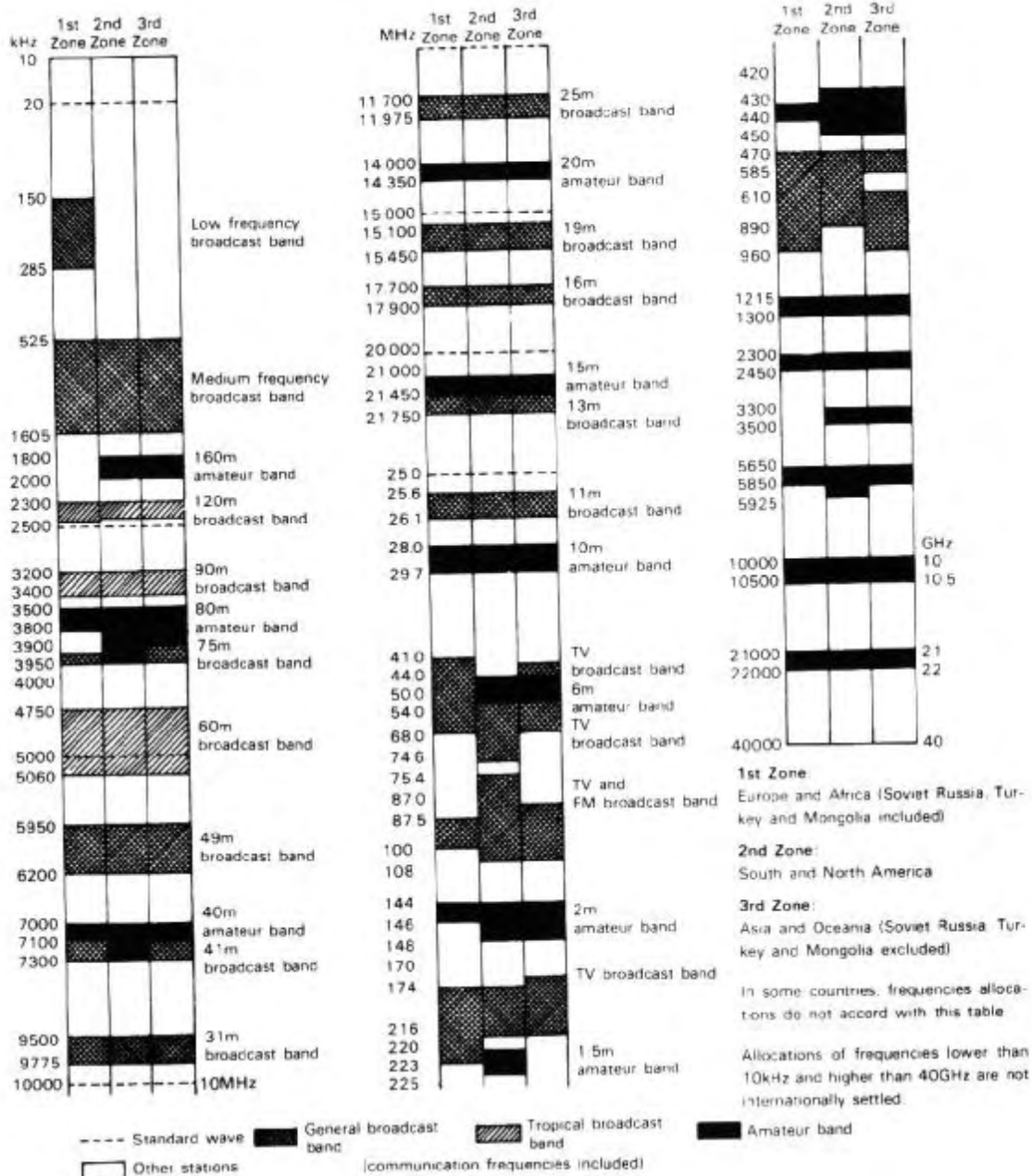

Fig. 4-2 Radio Frequency Allocation

SECTION 5. ADDITIONAL INFORMATION

■ IMPROVING THE SELECTIVITY IN AM RECEPTION

The R-1000 is equipped with three filters; AM WIDE (12 kHz), AM NARROW (6 kHz) and SSB (2.7 kHz).

If you wish to sharpen the selectivity in AM reception, shift the connector as shown in the illustration. This results in changing AM selectivity from 12 kHz to 6 kHz in AM WIDE, and from 6 kHz to 2.7 kHz in AM NARROW.

Remove two rear feet placed on the REAR of R-1000 and then remove the top cover.

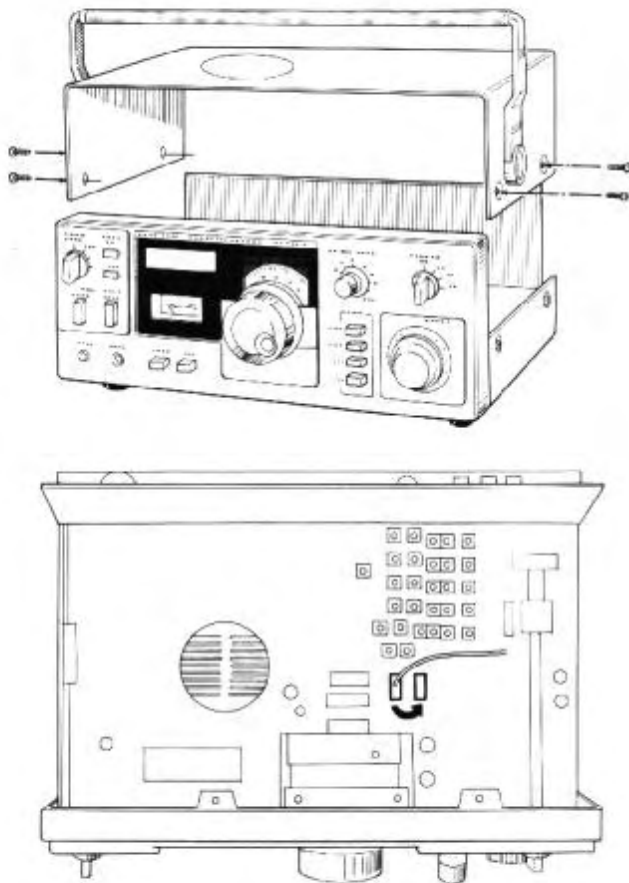

**OPTIONAL ACCESSORIES
WAHLWEISE ZUSATZEINRICH-
TUNGS**

External Speaker
Auben-Lautsprächer

Haut-parleur extérieur
Altavoz externo



SP-100

**ACCESSOIRES EN OPTION
ACCESORIOS OPCIONALES**

World Clock
Welt-Uhr

Horloge mondiale
Reloj mundial



HC-10

Head Phones
Kopf-Hörer

Casques d'écoute
Auriculares



HS-4

Ham Clock
Ham-Uhr

Horloge radio amateur
Reloj para radioaficionados



HC-2



HS-5

PETRA HENDERSON

888

KÜCHLER

Radio-HIFI
Fernsehen
Elektro

Tempelhofer Damm 131
1000 Berlin 42
☎ 7513004

Radio-HIFI
Fernsehen
Elektro

Scharnweberstr. 19
1000 Berlin 52
☎ 4123778

Radio-HIFI
Fernsehen
Elektro/Autoradio

Breite Str. 36
1000 Berlin 20
☎ 3332255

Autoradio
Funkcenter

Stresemannstr. 92
1000 Berlin 61
☎ 2511054

Senddienst und Zentrale: Stresemannstraße 92, 1000 Berlin 61, ☎ 2511054

Datum:

1.3.82

DM

Pf.

AR 1000 *2010481 1190

In dem Rechnungsbetrag sind

% MwSt. enthalten

1190,-

03912-26

Betrag dankend erhalten:

Unterschrift

A product of

TRIO-KENWOOD CORPORATION

17-5, 2-chome, Shibuya, Shibuya-ku, Tokyo, 150, Japan

TRIO-KENWOOD COMMUNICATIONS, INC.

1111, West Walnut Street, Compton, California, 90220, U.S.A

TRIO-KENWOOD COMMUNICATIONS, GmbH

D 6374 Steinbach TS, Industriestrasse 8A, West Germany

TRIO-KENWOOD (AUSTRALIA) PTY. LTD.

30 Whiting Street, Artarmon, Sydney N S W Australia 2064

©15104 PRINTED IN JAPAN B50-2685-10 (G)(W)(X)

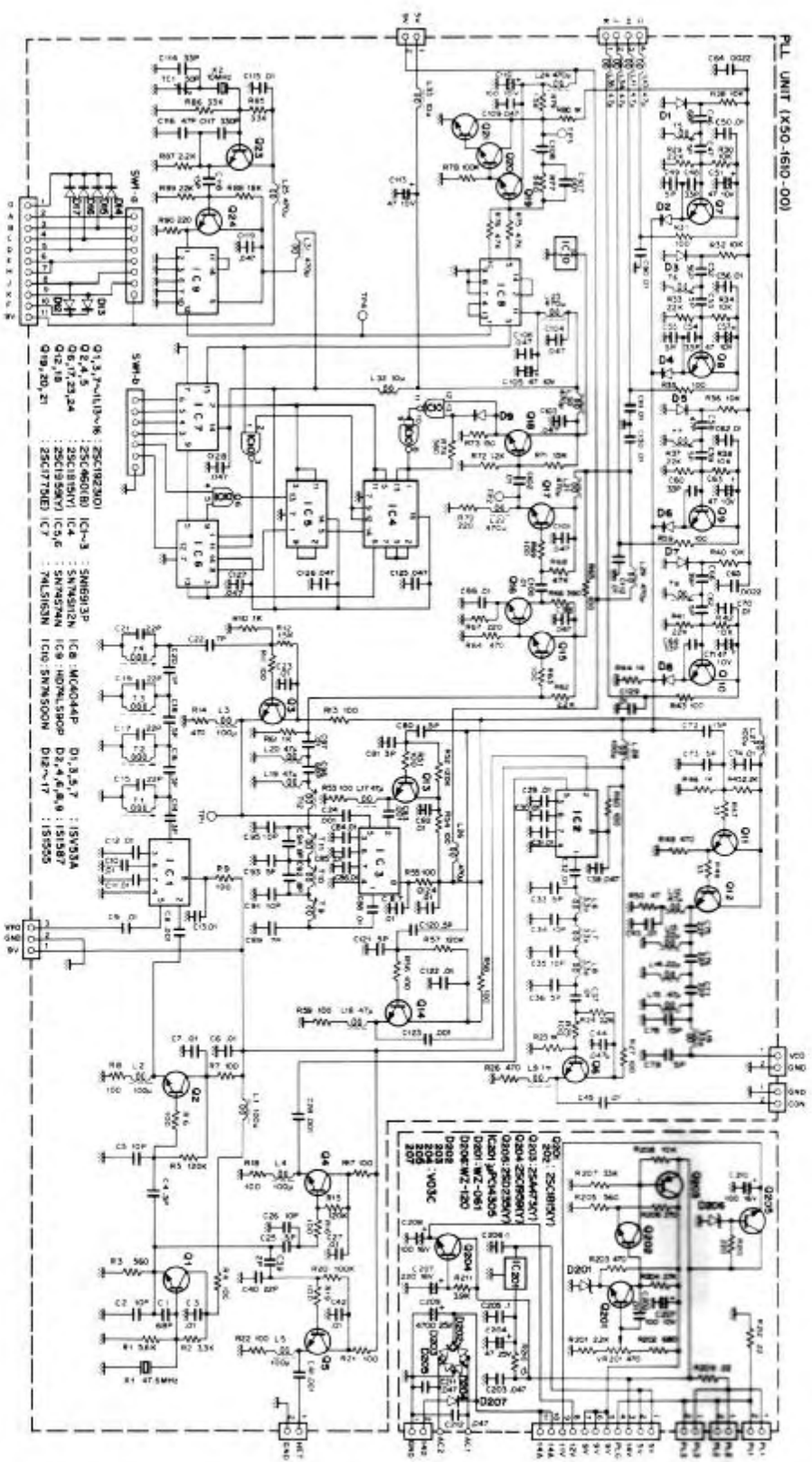

SCHMATIC DIAGRAM

SCHMATICSHES SCHALTBIID

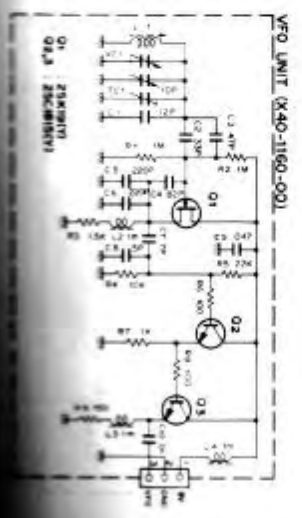

SCHEMA SIMPLIFIE

DIAGRAMA DEL CIRCUITO