



## MINIATURIZATION IN CONSUMER DEVICES

Delivering Ultra-Thin, High-Performance Inductor solutions for Next-Generation Wearables, Smart Cards, and Portable Electronic Devices

# The Need for Ultra-Thin Inductors in Small Consumer Devices

The push toward miniaturization in consumer electronics is driven by a persistent demand for more compact, powerful, and energy-efficient devices. The proliferation of wearables, smart cards, and other portable electronics has accelerated the need for components that not only save space but also enhance performance.

Designers of wearable devices such as fitness trackers, smartwatches, hearing aids, and wireless earbuds continually strive to reduce the size and weight while enhancing functionality. In these devices, power efficiency is crucial because prolonged battery life directly impacts the user experience. The challenge of achieving both miniaturization and efficiency requires advanced components that can meet stringent size, weight, and performance criteria.

Furthermore, the smart card industry is rapidly evolving, with applications ranging from biometric authentication and contactless payment systems to wireless charging asset trackers. These cards demand ultra-thin components that are robust, reliable, and highly efficient. Essential in power conversion and energy storage, inductors must be designed to accommodate the compact nature of these products.

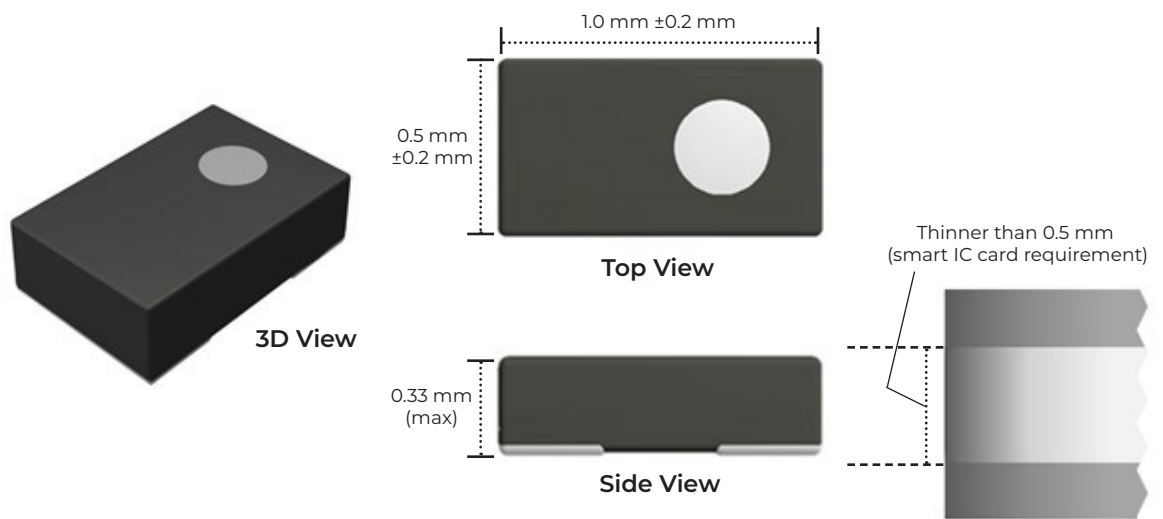

Figure 1: The LSCND1005CCTR47MH is thin enough to be used in a smart IC card.

The Internet of Things (IoT) and wearable technology markets are expanding rapidly, with new devices constantly being introduced that require power solutions optimized for size, efficiency, and performance. As devices shrink, engineers face increasing challenges associated with balancing size reduction with electrical performance, ensuring mechanical durability, and managing thermal characteristics. Power efficiency is a key consideration, particularly for battery-operated devices where energy conservation directly impacts user experience. In addition, maintaining reliability and robustness in smaller devices is essential, particularly for applications requiring continuous or high-current operation.

TAIYO YUDEN's LSCN series addresses these requirements by offering inductors that are not only ultra-thin but are also highly efficient and durable. For example, the recently introduced LSCND-1005CCTR47MH has been engineered to meet the stringent requirements of smart cards, fitness trackers, and other wearables. Its ultra-thin design empowers manufacturers to achieve greater miniaturization without sacrificing performance.

---

## Technical Overview of the LSCN Series

---

The LSCN series employs a multilayer metal structure designed to achieve excellent performance while maintaining a low profile. The manufacturing process involves layering iron core material and silver conductive traces, with the iron core penetrating all layers vertically. This unique construction ensures optimal magnetic performance by minimizing core loss and enhancing thermal stability.

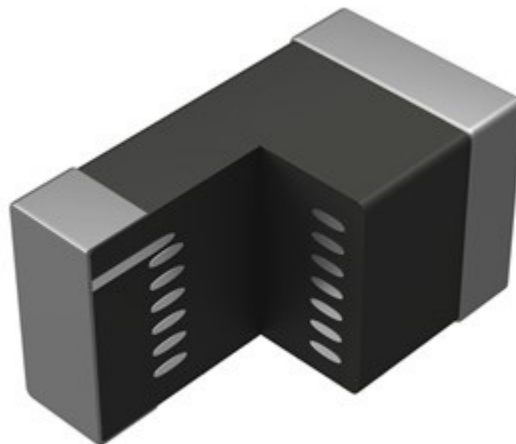

*Figure 2: The LSCN series employs a multilayer metal structure (not to scale).*

The absence of organic binders in the manufacturing process offers several key advantages:

- **High strength:** The material integrity is preserved, making the inductor more robust and reliable. This strength is essential for devices subjected to physical stress, such as wearables and smart cards.
- **High insulation:** The structure ensures excellent insulation properties, reducing the risk of electrical leakage, even in compact, densely packed circuits.
- **High magnetic permeability:** The use of iron core material enhances inductance characteristics, which is particularly important for improving power efficiency in ultra-thin designs.
- **Excellent heat resistance and thermal conductivity:** The inductor maintains performance even under high-temperature conditions. With its high thermal conductivity and excellent heat dissipation, it is less prone to heat buildup and generates less heat, thereby making it suitable for compact and sealed designs where heat dissipation is restricted.

**Specifications of the LSCND1005CCTR47MH:**

- Ultra-thin profile: 0.33 mm
- Inductance: 0.47  $\mu$ H
- Maximum DCR: 345 m $\Omega$  (typical 280 m $\Omega$ )
- Rated current: 1.4 A (typical 1.6 A)
- Operating temperature range: -40°C to +125°C

Case size 2012, t=1.0 mm, 0.24  $\mu$ H  
 Company A DCR: 19.1 m $\Omega$ , LCCN Series DCR: 15.1 m $\Omega$ \*

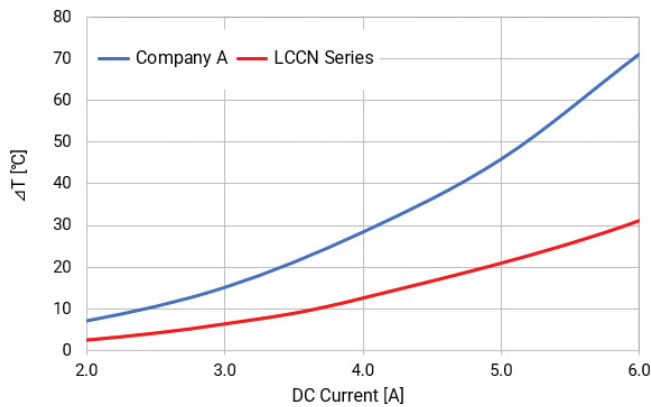

Case size 2012, t=1.0 mm, 1.0  $\mu$ H  
 Company A DCR: 71.6 m $\Omega$ , LCCN Series DCR: 71.0 m $\Omega$ \*

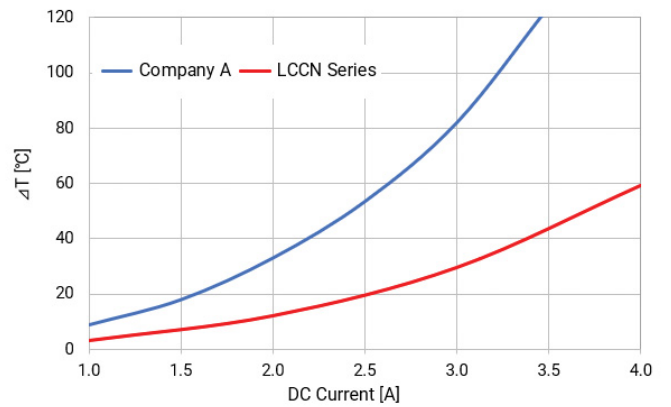

\*Condition: Environmental Temperature 25°C

Figure 3: Comparison of heat generation characteristics

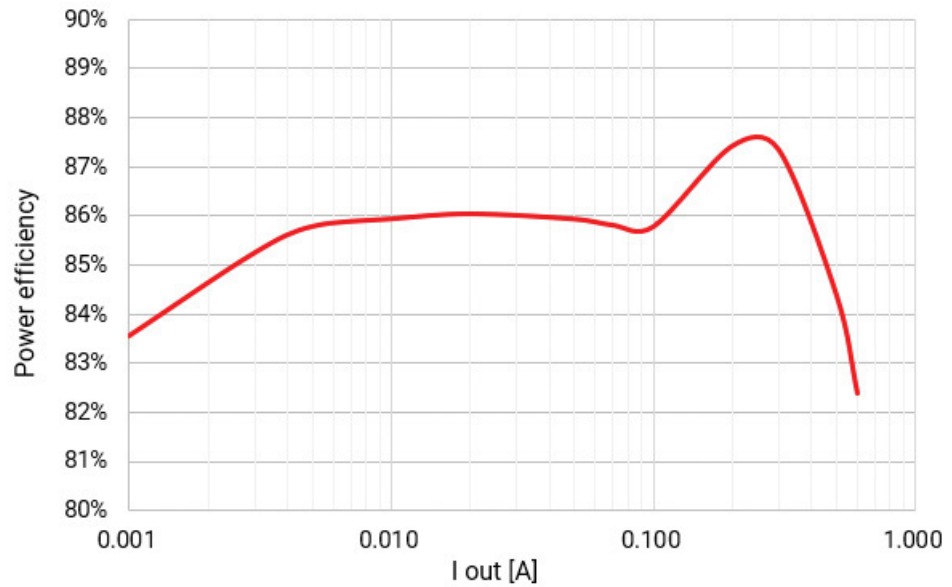

Figure 4: The LSCND1005CCTR47MH provides high power efficiency.

The high power efficiency of the LSCND1005CCTR47MH is achieved by high-performance metal materials and an innovative multilayer structure that optimizes magnetic properties and thermal characteristics. By minimizing power loss and enhancing heat dissipation, this inductor is ideally suited for applications for which energy efficiency and reliability are paramount.

---

## LSCND1005CCTR47MH - Design Advantages

---

This part is particularly well-suited for ultra-compact designs because it offers multiple advantages:

- **Miniaturization:** With a thickness of only 0.33 mm, this inductor is ideal for use in slim devices like smart cards, fitness trackers, and wearable medical devices.
- **High efficiency:** The design reduces core loss and improves power efficiency, which is critical for battery-operated devices.
- **High current-handling capability:** Despite its low-profile design, it can handle currents up to 1.4 A (1.6 A typical).
- **Compatibility with power management ICs:** Reference designs with the TOREX XC9291 demonstrate the LSCND1005CCTR47MH's high efficiency and excellent power-handling capabilities.

---

## LSCND1005CCTR47MH - Applications

---

The LSCND1005CCTR47MH is designed to meet the requirements of various ultra-thin electronic devices requiring efficient power management. Potential applications include:

- **Wearable devices:** Fitness trackers, smart glasses, hearing aids, and other compact electronic devices where space is a premium.
- **Smart cards:** Ultra-thin wireless charging solutions for wallet tracking, credit cards with biometric authentication, and employee ID cards with on-time password generation.
- **Other:** Due to its bottom electrode type, this device is suitable for high-density mounting. Also, its ultra-low profile makes it suitable for advanced applications, such as embedding in substrates.



## Comparison with Competing Inductors

When comparing the LSCND1005CCTR47MH to other inductors on the market, several aspects stand out. The part's ultra-thin profile, high efficiency, and compatibility with advanced power management ICs make it particularly competitive.

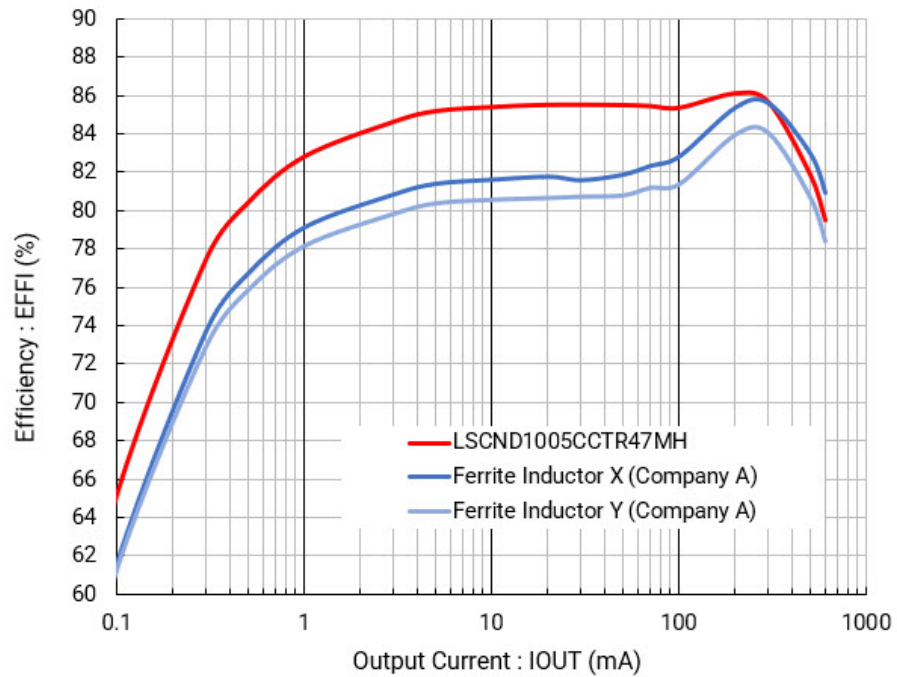

Power Efficiency Comparison: Metal vs. Ferrite		
Part	Height	Inductance
LSCND1005CCTR47MH, Metal, 1005	0.33 mm	0.47 $\mu$ H
Company A, Ferrite X, 1608	0.3 mm	0.47 $\mu$ H
Company A, Ferrite Y, 1005	0.75 mm	0.47 $\mu$ H

Figure 5: Power efficiency at different output currents (top) and metal vs. ferrite comparison (bottom).

Many conventional inductors cannot provide the same efficiency in such a compact form factor. Additionally, the LSCND1005CCTR47MH's ability to maintain performance across a wide temperature range gives it an edge over less-robust designs.

## Design Considerations for Engineers

Integrating the LSCND1005CCTR47MH into a design requires careful attention to layout, compatibility, and power management. Engineers must consider factors such as printed circuit board (PCB) layout, thermal management, and the appropriate selection of power management ICs to optimize performance.

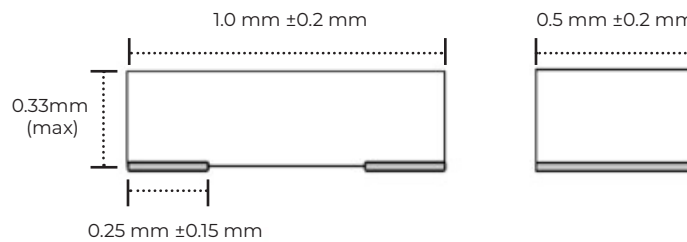

Figure 6: The LSCND1005CCTR47MH external dimensions (units: mm).

Proper placement and shielding of the inductor can impact efficiency, particularly in compact designs where space is limited.

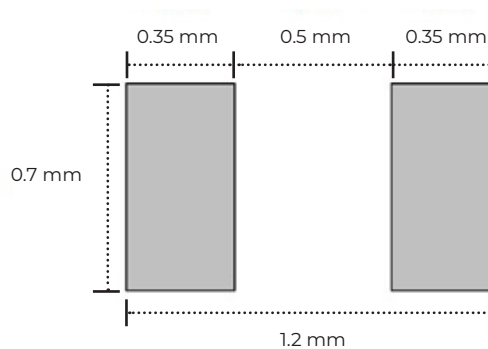

Figure 7: The LSCND1005CCTR47MH recommended land pattern (units: mm).

## Testing and Performance Validation

TAIYO YUDEN conducts extensive testing to validate the performance of all its components, including the LSCND1005CCTR47MH.

Rigorous quality control measures ensure that the LSCND1005CCTR47MH meets its specifications for inductance, current handling capability, DCR, and thermal performance.

Testing includes high-temperature endurance tests, vibration tests, and compatibility testing with various power management ICs, including the TOREX XC9291. These tests ensure reliability and efficiency in real-world applications.

## TAIYO YUDEN's Power Inductor Lineup

TAIYO YUDEN's product portfolio is extensive, covering high-value passive components designed for multiple applications. Its MCOIL series, which includes both wire-wound and multilayer inductors, provides optimal solutions for various applications where efficient power management is essential. The MCOIL family has become the preferred choice for many designers seeking high-performance inductors capable of handling high current or fitting into ultra-compact designs.

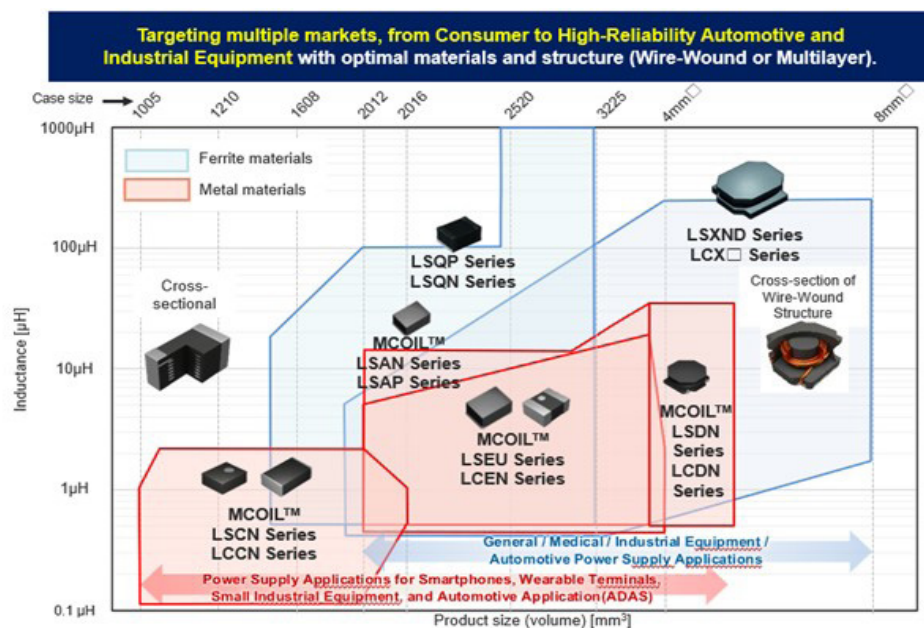

Figure 8: TAIYO YUDEN's power inductor lineup

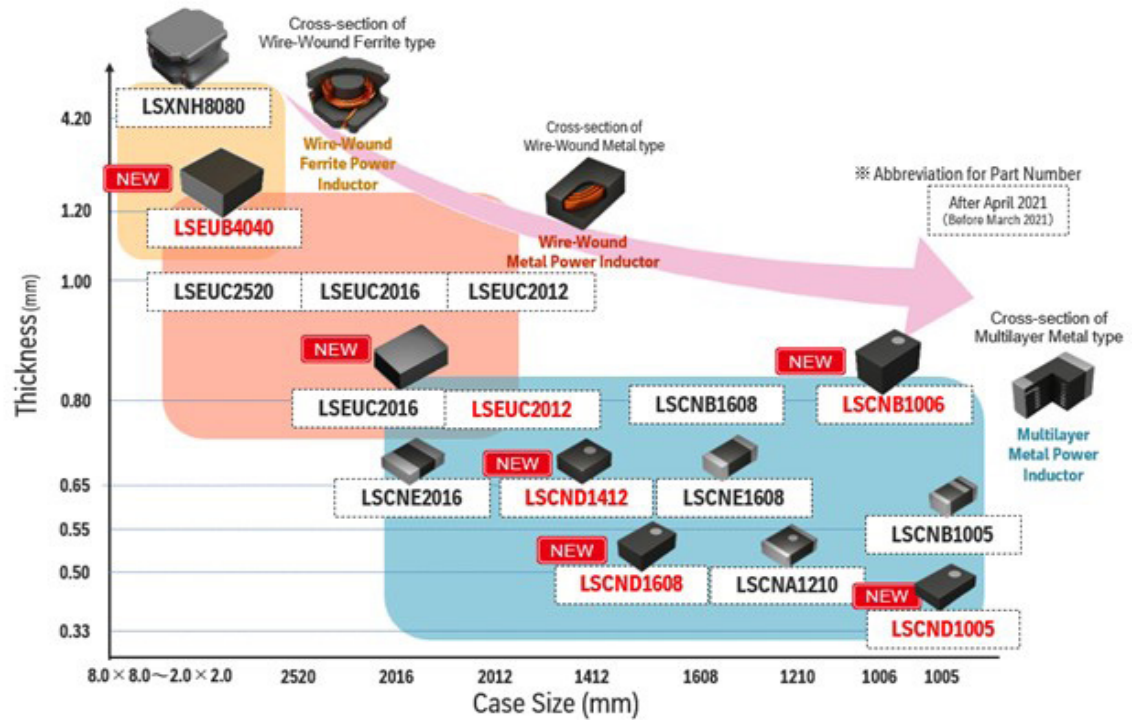

Figure 9: TAIYO YUDEN's power inductor lineup for consumer applications.

The company's ability to innovate continually in response to industry trends has enabled it to remain a leader in the development of miniaturized electronic components. The LSCN series, a subset of the MCOIL series, is specifically designed to meet the increasing demand for ultra-thin inductors that do not compromise performance. This series is distinguished by its compactness, high efficiency, and durability.

TY P/N	Size [mm]	Height [mm]	Inductance [uH]								
			0.1	0.24	0.33	0.47	0.56	0.68	1.0	1.5	2.2
LSCND1005CC (MCCC1005)	1.0x0.5	0.33				345 (280) 1.4 (1.6)					
LSCNB1005EE (MCEE1005)	1.0x0.5	0.55	50 (41) 2.0 (2.3)	80 (65)** 1.6 (1.8)		140 (114) 1.2 (1.4)			300 (244) 1.0 (1.2)		
LSCND1006HK (MCHK1006)	1.0x0.6	0.8									375(315) 0.8(0.95)
LSCNB1210EK (MCEK1210)	1.25x1.05	0.5				82 (70) 2.3 (2.6)			179 (157) 1.5 (1.7)	240 (200) 1.2 (1.4)	
LSCND1412FE (MCFE1412)	1.4x1.2	0.65	10 (8) 6.8 (7.4)	23 (19) 6.6 (7.6)	25 (20) 3.6 (4.1)	38 (35) 3.6 (4.1)					
LSCND1412HK (MCHK1412)		0.8		22(18) 6.5(6.9)	27(24) 5.4(6.2)						
LSCND1608EK (MCEK1608)	1.6x0.8	0.5			47(38) 3.0(3.4)						
LSCNA1608FK (MCFK1608)		0.6		50 (40) 2.3 (2.7)		85 (69) 1.9 (2.2)			224 (182) 1.5 (1.7)		
LSCNE1608FE (MCFE1608)		0.65		100 (75) 2.6 (3.1)		150 (114) 2.0 (2.4)			340 (270) 1.4 (1.7)		
LSCNB1608HK (MCHK1608)		0.8		24 (20) 4.3 (4.8)		43 (38) 3.3 (3.8)	55 (45) 2.7 (3.1)		110 (89) 2.2 (2.5)	200 (160) 1.7 (2.0)	292 (237) 1.5 (1.8)
LSCND1608HK (MCHK1608)											250(200) 1.3(1.5)
LSCND2012HK (MCHK2012)		2.0x1.2	0.8		19(16) 7.0(8.0)		26 (21) 4.8 (5.3)				
LSCNB2012HK (MCHK2012)						25(22) 5.4(6.2)					
LSCNA2012HK (MCHK2012)	2.0x1.25			24 (19) 4.32 (4.96)		36 (30) 3.21 (3.69)			111 (90) 2.26 (2.6)		
LSCNE2012HK (MCHK2012_KG)	2.0x1.25		12 (9.1) * 6.9 (7.9)	17 (14) 6.0 (7.0)		32 (26) 4.8 (5.0)					
LSCNA2012KK (MCKK2012)	2.0x1.25	1.0		25 (20) 6.2 (7.1)		39 (32) 4.5 (4.9)			90 (73) 3.6 (4.1)		
LSCNE2016FE (MCFE2016)	2.0x1.6	0.65				45 (40) 4.0 (4.7)		60 (50) 3.0 (3.6)	70 (60) 2.8 (3.4)		

Figure 10: TAIYO YUDEN's LSCN-series lineup.

The latest addition to the LSCN series is the LSCND1005CCTR47MH, a metal power inductor featuring an impressively thin profile of just 0.33 mm, making it ideal for space-constrained, power-efficient designs.

## Conclusion and Outlook

TAIYO YUDEN is a leading manufacturer of passive components, with an enviable reputation for its innovative solutions in multilayer ceramic capacitors, aluminum electrolytic capacitors, and inductors.

Founded in 1950, the company has consistently demonstrated its commitment to developing advanced materials and manufacturing processes aimed at meeting the ever-evolving demands of the electronics industry. With a broad product portfolio covering components designed for automotive, industrial, medical, and consumer electronics, TAIYO YUDEN has established itself as a trusted supplier of high-quality, reliable solutions.

As the demand for compact, power-efficient devices continues to grow, TAIYO YUDEN has positioned itself at the forefront of miniaturization technology, particularly for consumer electronics such as wearables, fitness trackers, smart cards, and other portable devices. By leveraging its expertise in high-value passive components, TAIYO YUDEN strives to provide cutting-edge solutions that enhance device performance while reducing size.

The LSCND1005CCTR47MH exemplifies TAIYO YUDEN's commitment to developing innovative, high-performance solutions for small consumer electronics. Its combination of ultra-thin profile, high efficiency, and compatibility with modern power management ICs positions it as a vital component in the continued evolution of miniaturized devices.

As the demand for ultra-thin electronics grows, TAIYO YUDEN will continue to expand its LSCN series, further enhancing the performance and capabilities of miniaturized devices.

---

## Additional Tools and Resources

---

- **Product Search Tool (TAIYO YUDEN TY-Compas)**  
<https://ds.yuden.co.jp/TYCOMPAS/ut/searcherMain>
- **Power Inductor Selection Tool (TAIYO YUDEN TY-PIST)**  
<https://md.yuden.co.jp/TYPIST/ut/selection.html>
- **Easy PDN Tool (TAIYO YUDEN TY-PDN Tool)**  
<https://www.yuden.co.jp/ut/product/support/pdntool/>
- **Component Library for integration support**  
[https://www.yuden.co.jp/ut/product/support/com\\_lib/](https://www.yuden.co.jp/ut/product/support/com_lib/)
- **Evaluation IC: TOREX Semiconductor XC9291**  
<https://product.torexsemi.com/en/series/xc9291>

## About TAIYO YUDEN

TAIYO YUDEN is an electronic components manufacturer that was founded in 1950. We are engaged in research and development, production, and sales of various electronic components such as capacitors, inductors, and FBAR/SAW devices, and are expanding our business globally.

To provide products that meet the needs of our customers and society, we firmly believe in creating products starting from the development of materials. As a result, our products have been highly rated in a wide range of fields, including electronic devices such as smartphones and tablets, automobiles which are rapidly being transformed by IT and electronics technology, and information infrastructure and industrial equipment.

## About Torex Semiconductor

Torex Semiconductor Ltd. is a leading provider of CMOS power management ICs targeted toward battery powered and energy efficient applications. Torex specializes in CMOS analog technology, with LDO voltage regulators, voltage detectors and DC/DC converters making up our core product offering.

Torex Semiconductor Ltd: <https://www.torexsemi.com/>

MCOIL is a registered trademark or trademark of TAIYO YUDEN CO., LTD. in Japan and other countries. The names of series noted in the text are excerpted from part numbers that indicate the types and characteristics of the products, and therefore are neither product names nor trademarks.

TAIYO YUDEN (U.S.A.) INC.  
2077 Gateway Place, Suite 350, San Jose, CA 95110  
<https://www.t-yuden.com>

This paper's information is subject to change without notice.

© 2025 TAIYO YUDEN (U.S.A.) INC.

All Rights Reserved.

Pub: July 2025



TAIYO YUDEN



› TAIYO YUDEN  
**My TAIYO**

A free customer membership  
service by TAIYO YUDEN USA



### Free Sample Kits

Request and try out our products for your project needs.  
\*Free sample kits are offered upon TAIYO YUDEN's approval.



### Product Updates

Stay up to date about TAIYO YUDEN's market offerings.



### Members-Only Newsletters

Receive TAIYO YUDEN's corporate updates, special content, etc.



**Sign Up Now**

[www.t-yuden.info](http://www.t-yuden.info)



Address: 2077 Gateway Place, Suite 350, San Jose CA 95110  
E-mail: [mytaiyo@t-yuden.com](mailto:mytaiyo@t-yuden.com) | Web: [www.t-yuden.info](http://www.t-yuden.info)